

SKiiP 22NAB126V10

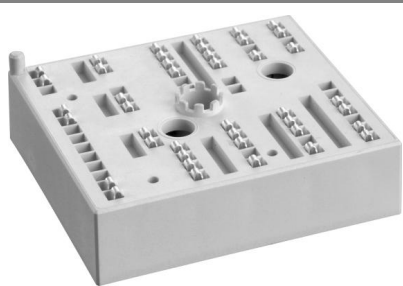

MiniSKiiP[®] 2

3-phase bridge rectifier +
brake chopper + 3-phase
bridge inverter
SKiiP 22NAB126V10

Preliminary Data

Features

- Fast Trench IGBTs
- Robust and soft freewheeling diodes in CAL technology
- Highly reliable spring contacts for electrical connections
- UL recognised file no. E63532

Typical Applications

- Inverter up to 10 kVA
- Typical motor power 5,5 kW

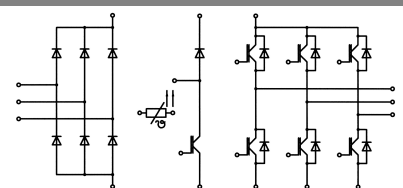

NAB

Absolute Maximum Ratings		$T_s = 25\text{ }^\circ\text{C}$, unless otherwise specified	
Symbol	Conditions	Values	Units
IGBT - Inverter, Chopper			
V_{CES}		1200	V
I_C	$T_s = 25\text{ (70) }^\circ\text{C}$	28 (22)	A
I_{CRM}	$T_s = 25\text{ (70) }^\circ\text{C}$, $t_p \leq 1\text{ ms}$	56 (44)	A
V_{GES}		± 20	V
T_j		- 40 ... + 150	$^\circ\text{C}$
Diode - Inverter, Chopper			
I_F	$T_s = 25\text{ (70) }^\circ\text{C}$	26 (20)	A
I_{FRM}	$T_s = 25\text{ (70) }^\circ\text{C}$, $t_p \leq 1\text{ ms}$	52 (40)	A
T_j		- 40 ... + 150	$^\circ\text{C}$
Diode - Rectifier			
V_{RRM}		1600	V
I_F	$T_s = 70\text{ }^\circ\text{C}$	61	A
I_{FSM}	$t_p = 10\text{ ms}$, $\sin 180^\circ$, $T_j = 25\text{ }^\circ\text{C}$	700	A
i^2t	$t_p = 10\text{ ms}$, $\sin 180^\circ$, $T_j = 25\text{ }^\circ\text{C}$	2400	A^2s
T_j		- 40 ... + 150	$^\circ\text{C}$
I_{tRMS}	per power terminal (20 A / spring)	40	A
T_{stg}	$T_{op} \leq T_{stg}$	- 40 ... + 125	$^\circ\text{C}$
V_{isol}	AC, 1 min.	2500	V

Characteristics		$T_s = 25\text{ }^\circ\text{C}$, unless otherwise specified			
Symbol	Conditions	min.	typ.	max.	Units
IGBT - Inverter, Chopper					
V_{CEsat}	$I_C = 15\text{ A}$, $T_j = 25\text{ (125) }^\circ\text{C}$		1,7 (2)	2,1 (2,4)	V
$V_{GE(th)}$	$V_{GE} = V_{CE}$, $I_C = 0,6\text{ mA}$	5	5,8	6,5	V
$V_{CE(TO)}$	$T_j = 25\text{ (125) }^\circ\text{C}$		1 (0,9)	1,2 (1,1)	V
r_T	$T_j = 25\text{ (125) }^\circ\text{C}$		47 (73)	60 (87)	$\text{m}\Omega$
C_{ies}	$V_{CE} = 25\text{ V}$, $V_{GE} = 0\text{ V}$, $f = 1\text{ MHz}$		1		nF
C_{oes}	$V_{CE} = 25\text{ V}$, $V_{GE} = 0\text{ V}$, $f = 1\text{ MHz}$		0,1		nF
C_{res}	$V_{CE} = 25\text{ V}$, $V_{GE} = 0\text{ V}$, $f = 1\text{ MHz}$		0,1		nF
$R_{th(j-s)}$	per IGBT		1,15		K/W
$t_{d(on)}$	under following conditions		25		ns
t_r	$V_{CC} = 600\text{ V}$, $V_{GE} = \pm 15\text{ V}$		25		ns
$t_{d(off)}$	$I_C = 15\text{ A}$, $T_j = 125\text{ }^\circ\text{C}$		385		ns
t_f	$R_{Gon} = R_{Goff} = 30\text{ }\Omega$		90		ns
E_{on}	inductive load		2		mJ
E_{off}			1,85		mJ
Diode - Inverter, Chopper					
$V_F = V_{EC}$	$I_F = 15\text{ A}$, $T_j = 25\text{ (125) }^\circ\text{C}$		1,6 (1,6)	1,8 (1,8)	V
$V_{(TO)}$	$T_j = 25\text{ (125) }^\circ\text{C}$		1 (0,8)	1,1 (0,9)	V
r_T	$T_j = 25\text{ (125) }^\circ\text{C}$		40 (53)	47 (60)	$\text{m}\Omega$
$R_{th(j-s)}$	per diode		1,95		K/W
I_{RRM}	under following conditions		25		A
Q_{rr}	$I_F = 15\text{ A}$, $V_R = 600\text{ V}$		3		μC
E_{rr}	$V_{GE} = 0\text{ V}$, $T_j = 125\text{ }^\circ\text{C}$		1,1		mJ
	$di_F/dt = 900\text{ A}/\mu\text{s}$				
Diode - Rectifier					
V_F	$I_F = 35\text{ A}$, $T_j = 25\text{ }^\circ\text{C}$		1,1		V
$V_{(TO)}$	$T_j = 150\text{ }^\circ\text{C}$		0,8		V
r_T	$T_j = 150\text{ }^\circ\text{C}$		11		$\text{m}\Omega$
$R_{th(j-s)}$	per diode		0,9		K/W
Temperature Sensor					
R_{ts}	3 %, $T_r = 25\text{ (100) }^\circ\text{C}$		1000(1670)		Ω
Mechanical Data					
w			95		g
M_s	Mounting torque	2		2,5	Nm

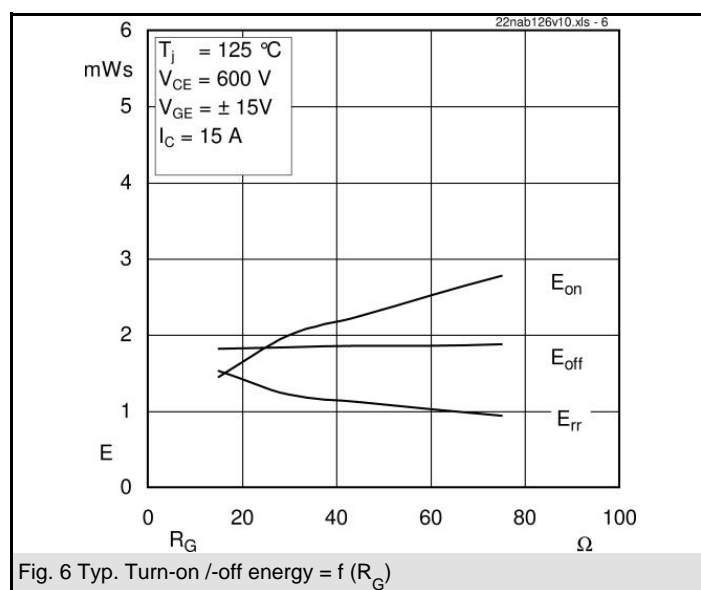
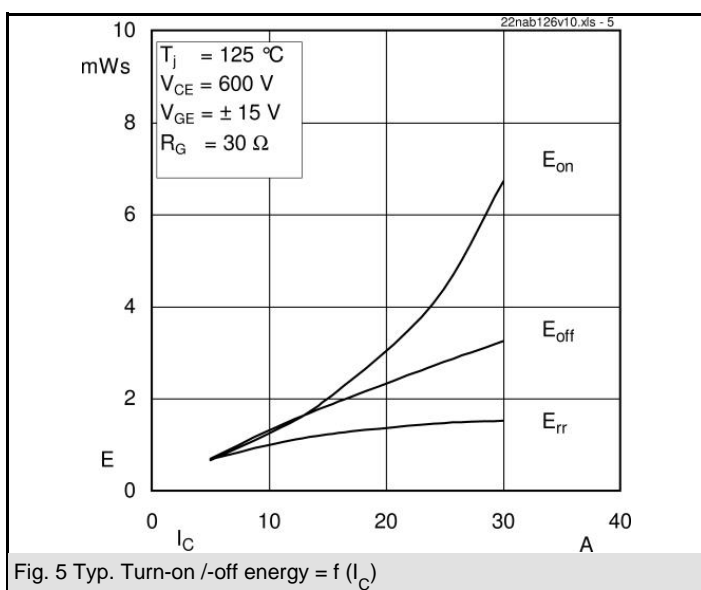
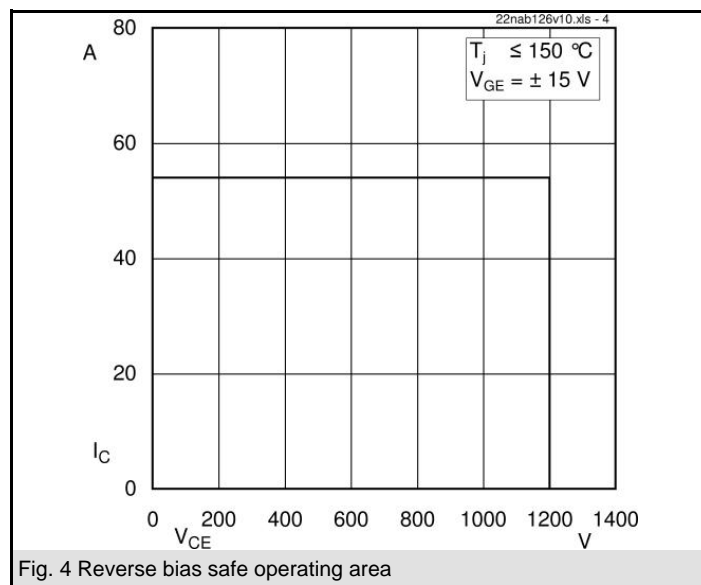
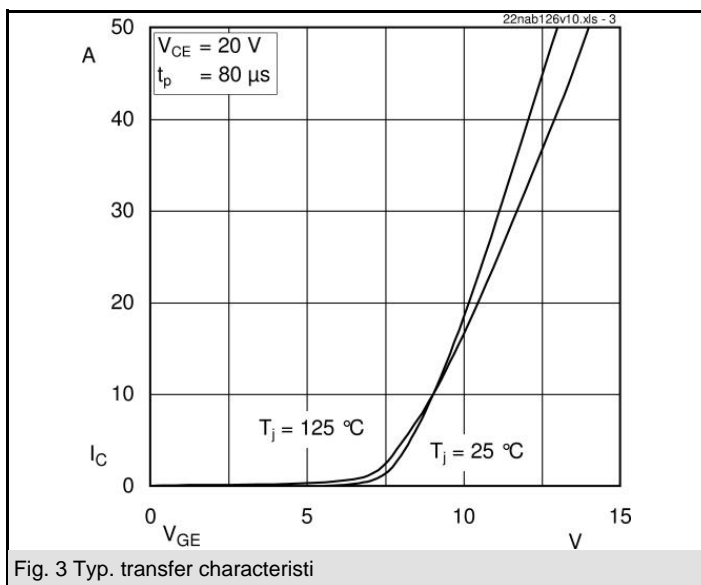
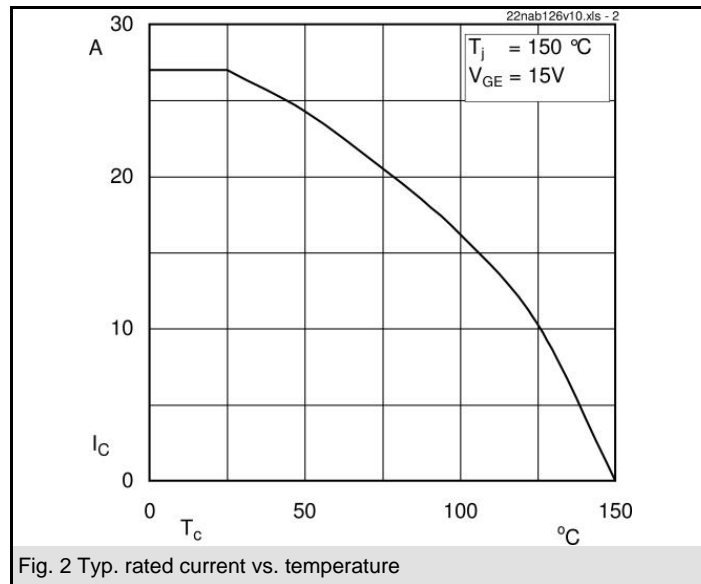
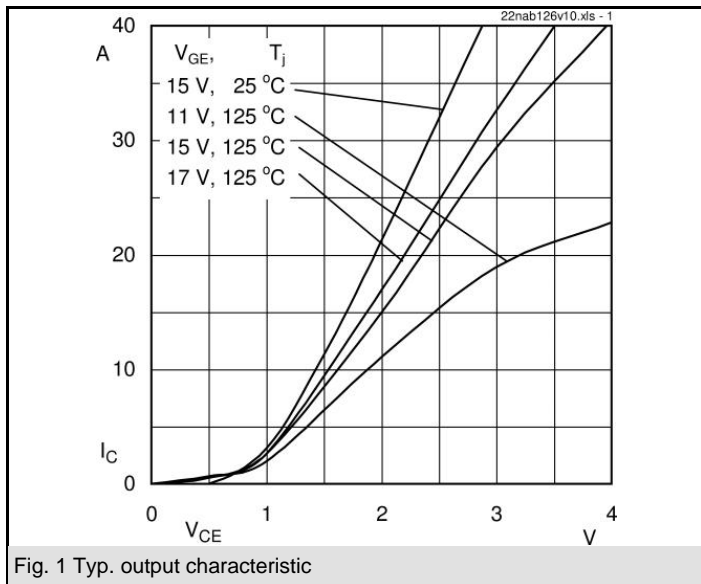

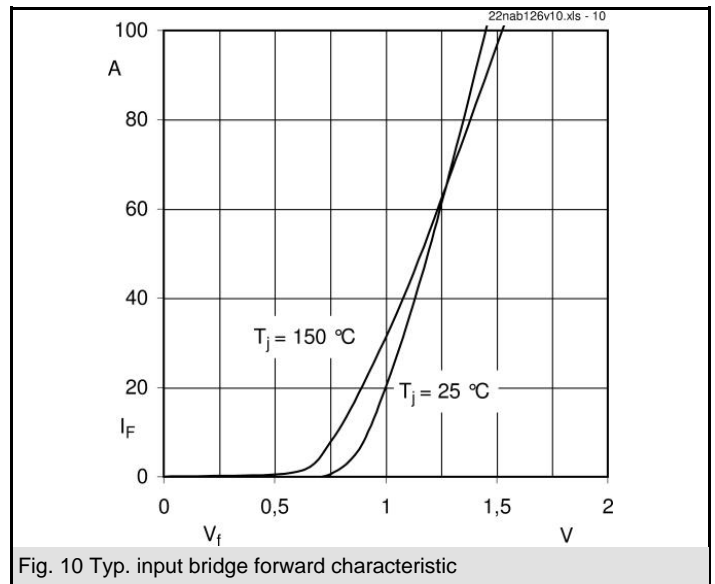
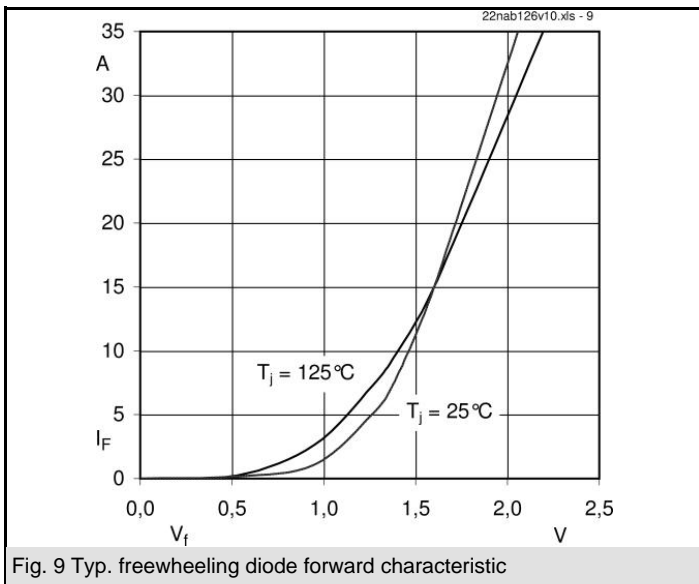
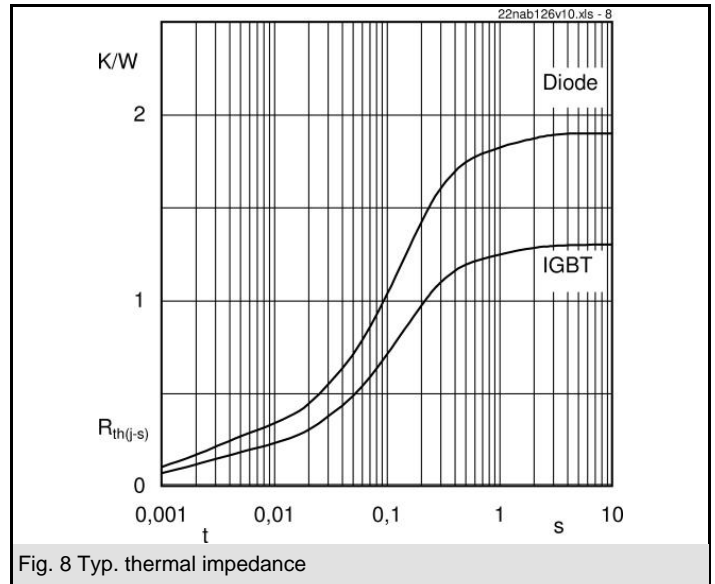
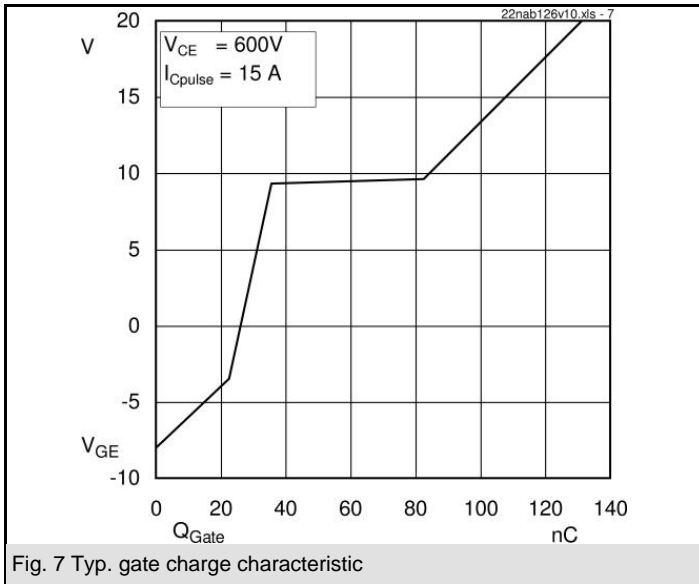

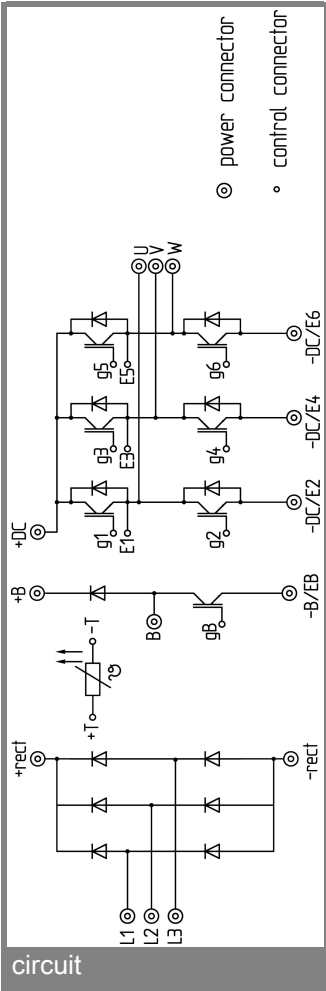

circuit

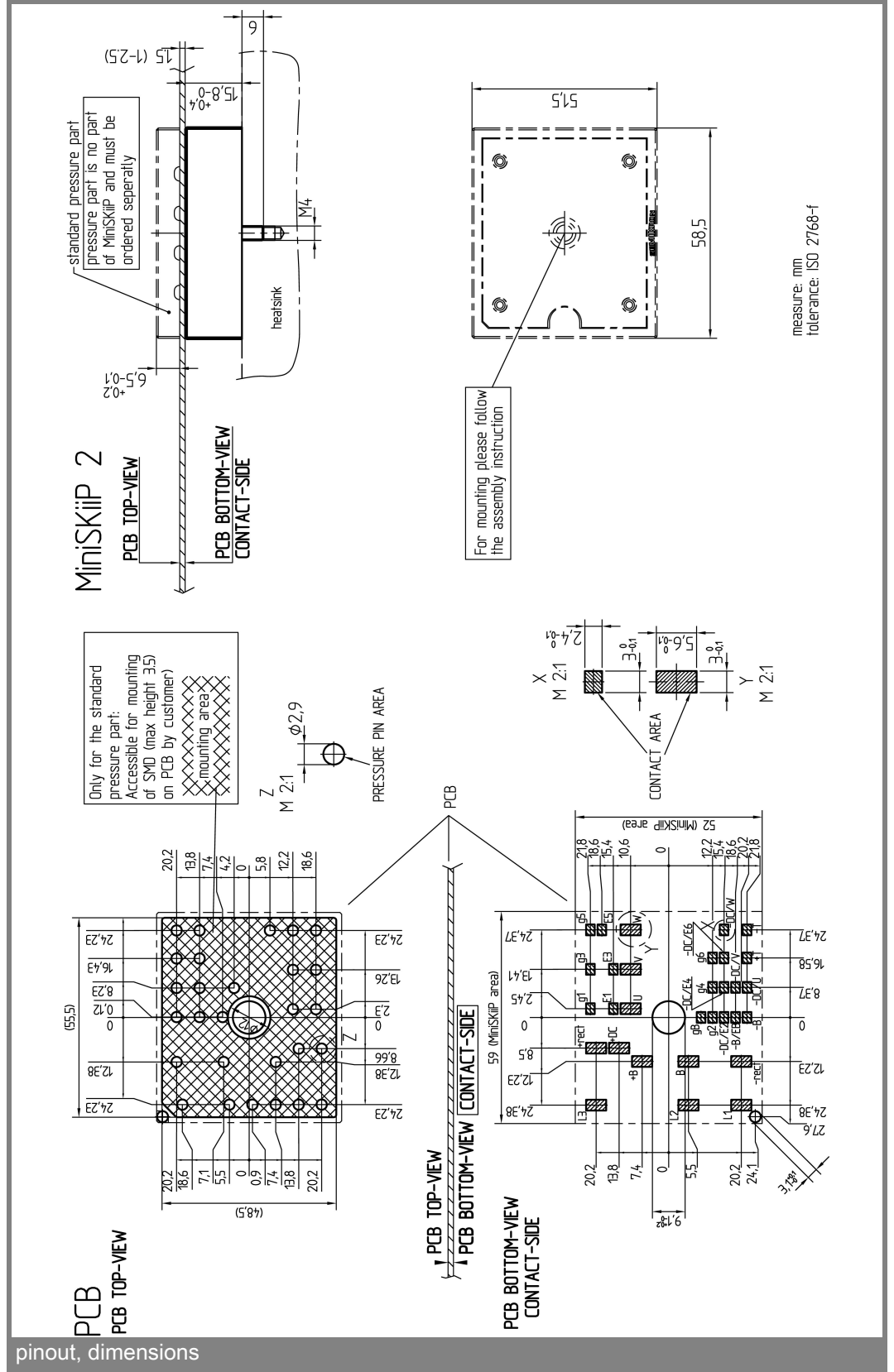

This is an electrostatic discharge sensitive device (ESDS), international standard IEC 60747-1, Chapter IX.

This technical information specifies semiconductor devices but promises no characteristics. No warranty or guarantee expressed or implied is made regarding delivery, performance or suitability.